



**eC H<sub>2</sub>O**<sup>TM</sup>  
ELECTRICALLY CONVERTED WATER

**FaST**  
Foam Scrubbing Technology

*The Safe Scrubbing Alternative*<sup>®</sup>

**SPEED SCRUB**<sup>®</sup>

17 in / 20 in / 24 in AUTOMATIC SCRUBBER

**OPERATOR MANUAL**

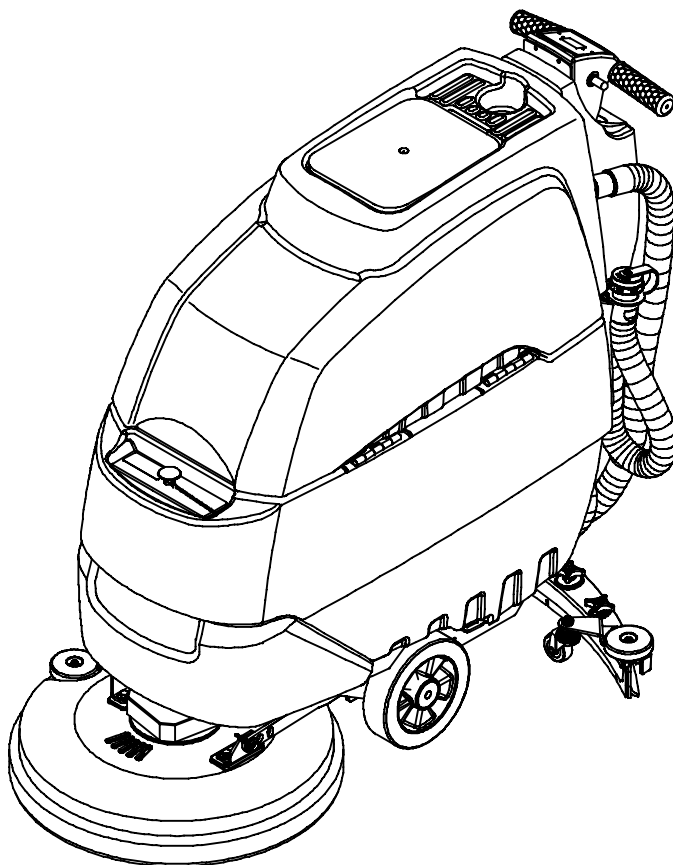

# OPERATION

This manual is furnished with each new model. It provides necessary operation and maintenance instructions.

**Read this manual completely and understand the machine before operating or servicing it.**

This machine will provide excellent service. However, the best results will be obtained at minimum costs if:

- The machine is operated with reasonable care.
- The machine is maintained regularly - per the machine maintenance instructions provided.
- The machine is maintained with manufacturer supplied or equivalent parts.

Parts and supplies may be ordered online, by phone, by fax or by mail.



**PROTECT THE ENVIRONMENT**

Please dispose of packaging materials, old machine components such as batteries, hazardous fluids, including anti-freeze and oil, in an environmentally safe way according to local waste disposal regulations.



Always remember to recycle.

## MACHINE DATA

Please fill out at time of installation for future reference.

Model No. - \_\_\_\_\_

Serial No. - \_\_\_\_\_

Machine Options - \_\_\_\_\_

Sales Rep. - \_\_\_\_\_

Sales Rep. phone no. - \_\_\_\_\_

Customer Number - \_\_\_\_\_

Installation Date - \_\_\_\_\_

## TABLE OF CONTENTS

<b>SAFETY PRECAUTIONS</b> .....	<b>3</b>
<b>SAFETY LABELS</b> .....	<b>4</b>
<b>MACHINE COMPONENTS</b> .....	<b>5</b>
<b>CONTROL PANEL COMPONENTS</b> .....	<b>6</b>
<b>MACHINE INSTALLATION</b> .....	<b>7</b>
<b>HOW THE MACHINE WORKS</b> .....	<b>8</b>
<b>BRUSH AND PAD INFORMATION</b> .....	<b>8</b>
<b>MACHINE SETUP</b> .....	<b>9</b>
<b>MACHINE OPERATION</b> .....	<b>11</b>
<b>DRAINING TANKS</b> .....	<b>15</b>
<b>CHARGING BATTERIES</b> .....	<b>16</b>
<b>MACHINE MAINTENANCE</b> .....	<b>19</b>
<b>TRANSPORTING MACHINE</b> .....	<b>26</b>
<b>STORING MACHINE</b> .....	<b>26</b>
<b>RECOMMENDED STOCK ITEMS</b> .....	<b>28</b>
<b>TROUBLESHOOTING</b> .....	<b>29</b>
<b>BATTERY METER LED FAULT CODES</b> .....	<b>31</b>
<b>MACHINE SPECIFICATIONS</b> .....	<b>32</b>
<b>MACHINE DIMENSIONS</b> .....	<b>33</b>

**Tennant Company**  
PO Box 1452  
Minneapolis, MN 55440 USA  
Phone: (800) 553-8033 or (763) 513-2850  
www.nobles.com

Specifications and parts are subject to change without notice.

Original instructions, copyright 2008, 2010 TENNANT Company.  
All rights reserved.

---

## SAFETY PRECAUTIONS

---

This machine is intended for commercial use. It is designed exclusively to scrub hard floors in an indoor environment and is not constructed for any other use. Only use recommended pads, brushes and commercially approved floor cleaners intended for machine application.

The following warning alert symbol and the “FOR SAFETY” heading are used throughout this manual as indicated in their description:

**⚠ WARNING:** To warn of hazards or unsafe practices which could result in severe personal injury or death.

**FOR SAFETY:** To identify actions which must be followed for safe operation of equipment.

---

The following safety precautions signal potentially dangerous conditions to the operator or equipment. All operators must read, understand and practice them.

**⚠ WARNING:** Fire Or Explosion Hazard:

- Never Use Flammable Liquids Or Operate Machine in Or Near Flammable Liquids, Vapors Or Combustible Dusts.

This machine is not equipped with explosion proof motors. The electric motors will spark upon start up and during operation which could cause a flash fire or explosion if machine is used in an area where flammable vapors/liquids or combustible dusts are present.

- Do Not Pick Up Flammable Materials Or Reactive Metals.
- Batteries Emit Hydrogen Gas. Keep Sparks And Open Flame Away. Keep Battery Compartment Open When Charging.

**⚠ WARNING:** Electrical Hazard

- Disconnect Battery Cables and Charger Plug Before Servicing Machine.
- Do Not Charge Batteries with Damaged Power Supply Cord. Do Not Modify Plug.

If the charger supply cord is damaged or broken, it must be replaced by the manufacturer or its service agent or a similarly qualified person in order to avoid a hazard.

**⚠ WARNING:** Spinning Brush. Keep Hands Away. Turn Off Power Before Working On Machine.

## FOR SAFETY:

1. Do not operate machine:
  - With flammable liquids or near flammable vapors as an explosion or flash fire may occur.
  - Unless trained and authorized.
  - Unless operator manual is read and understood.
  - If not in proper operating condition.
2. Before starting machine:
  - Make sure all safety devices are in place and operate properly.
3. When using machine:
  - Go slow on inclines and slippery surfaces.
  - Wear non-slip shoes.
  - Reduce speed when turning.
  - Report machine damage or faulty operation immediately.
  - Never allow children to play on or around.
  - Follow mixing and handling instructions on chemical containers.
  - Do not operate on inclines that exceed 5% (3°).
4. Before leaving or servicing machine:
  - Stop on level surface.
  - Turn off machine.
  - Set parking brake, if equipped.
  - Remove key.
5. When servicing machine:
  - Avoid moving parts. Do not wear loose jackets, shirts, or sleeves.
  - Disconnect battery connections before working on machine.
  - Wear protective gloves and eye protection when handling batteries or battery cables.
  - Avoid contact with battery acid.
  - Wear protective gloves and eye protection when handling white vinegar.
  - Do not power spray or hose off machine. Electrical malfunction may occur.
  - Use manufacturer supplied or approved replacement parts.
  - All repairs must be performed by a qualified service person.
  - Do not modify the machine from its original design.

## OPERATION

### 6. When transporting machine by use of truck or trailer:

- Drain tanks before loading.
- Use a ramp that can support the machine weight and person loading it. Do not exceed a 11° ramp incline at a ramp length of 12 ft (3.7m).
- Turn machine off.
- Put scrub head in the lowered position.
- Block machine wheels.
- Use tie-down straps to secure machine.
- Set parking brake, if equipped.

## SAFETY LABELS

The safety labels appear on the machine in the locations indicated. Replace labels if they are missing or become damaged or illegible.

**WARNING LABEL** - Located on recovery tank cover.



**SPINNING BRUSH LABEL** - Located on scrub head

**⚠ WARNING: Spinning Brush. Keep Hands Away. Turn Off Power Before Working On Machine.**



**BATTERY CHARGE LABEL** - Located on bottom side of recovery tank.

**⚠ WARNING: Fire Or Explosion Hazard. Batteries Emit Hydrogen Gas. Keep Sparks And Open Flame Away. Keep Battery Compartment Open When Charging.**

MACHINE COMPONENTS



- 1. Adjustable Control Handle
- 2. Control Console Panel
- 3. Recovery Tank Drain Hose
- 4. Squeegee Lift Lever
- 5. Battery Charge Receptacle
- 6. Hose Fill-Port
- 7. Solution Tank Sight Gauge/Drain Hose
- 8. Down Pressure Lever
- 9. Scrub Head Lift Pedal
- 10. Squeegee Assembly
- 11. Solution Flow Control Knob
- 12. Solution Tank filter
- 13. Wall Rollers

- 14. On-board Battery Charger
- 15. Recovery Tank Support Stand
- 16. Batteries
- 17. Solution Tank/Bucket Fill Port
- 18. FaST-PAK Concentrate (FaST Model)
- 19. Recovery Tank
- 20. Recovery Tank Cover
- 21. Cup Holder
- 22. Scrub Head
- 23. Scrub Head Skirt
- 24. Scrub Head Window
- 25. Motor Hub Lock Pin
- 26. Parking Brake (option)
- 27. *ec-H2O* System Module (*ec-H2O* Model)

# OPERATION

## CONTROL PANEL COMPONENTS

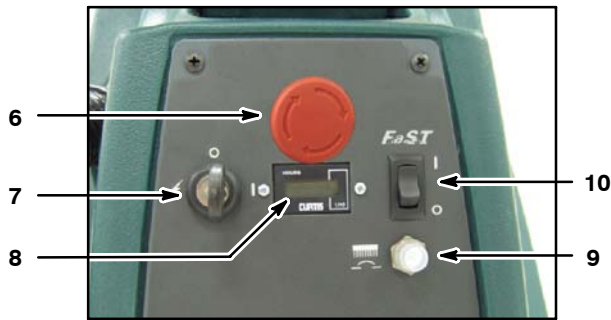
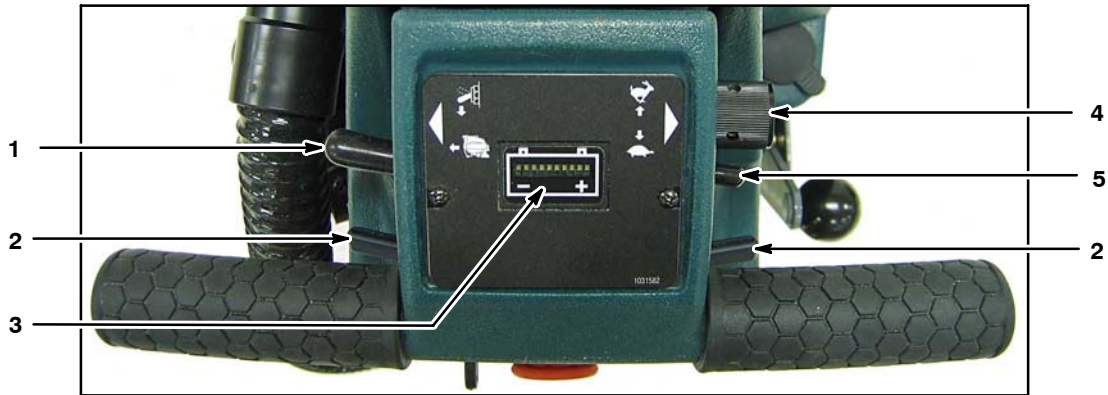

ec-H2O Model

- 1. Reverse Trigger
- 2. Start Triggers
- 3. Battery Meter
- 4. Speed Control Knob (drive model)
- 5. Control Console Height Adjustment Lever
- 6. Emergency Stop Button (option)
- 7. Main Power on/off Key Switch
- 8. Hour Meter
- 9. Brush Motor Circuit Breaker Button
- 10. FaST System on/off Switch (FaST Model)  
ec-H2O system on/off switch (ec-H2O Model)
- 11. ec-H2O System Indicator light (ec-H2O Model)

## MACHINE INSTALLATION

### UNCRATING MACHINE

1. Carefully check the shipping crate for signs of damage. Report damages at once to carrier.
2. Check the contents list. Contact distributor for missing items.

Contents:

- 2-12 V Batteries - Optional
- 24V Battery Charger - Optional
- 3-Foam Battery Spacers (#630375)
- Battery Tray (#1012994)
- 15 in / 38 cm Battery Cable (#130364)
- 4-Battery Cable Rubber Boots
- 1-FaST-PAK MP Concentrate (#1017019) (FaST Model)
- Squeegee Assembly (#9001178)
- Pad Driver - Optional

*Brushes and pads must be purchased separately.*

3. To uncrate your machine, remove the shipping hardware and straps that secure the machine to the pallet. With assistance, carefully lift the machine off the pallet.

**ATTENTION: Do not roll machine off pallet unless a ramp is used, machine damage may occur.**

**ATTENTION: To prevent possible machine damage, install batteries after removing machine from shipping pallet.**

### INSTALLING BATTERIES

**⚠ WARNING: Fire Or Explosion Hazard. Batteries Emit Hydrogen Gas. Keep Sparks And Open Flame Away. Keep Battery Hood Open When Charging.**

**FOR SAFETY: When servicing machine, wear protective gloves and eye protection when handling batteries and battery cables. Avoid contact with battery acid.**

#### Recommended Battery Specifications:

Two 12 volt deep cycle lead acid batteries.

105 AH battery - 17 in / 43cm Brush Assist Model

130 AH battery - 20 in / 50cm Brush Assist Model

155 AH battery - 20 in / 50cm Drive Model

Maximum battery dimensions: 6.85 in / 174 mm W x 15 in / 380 mm L x 11.18 in / 284 mm H.

1. Park the machine on a level surface, remove the key and set the parking brake if equipped.
2. Lift the recovery tank to access the battery compartment (Figure 1).



FIG. 1

3. Carefully install the batteries into the battery compartment tray and arrange the battery posts as shown (Figure 2). Insert the foam spacers as shown.
4. Connect the battery cables to the battery posts as shown (Figure 2). RED TO POSITIVE (+) and BLACK TO NEGATIVE (-).

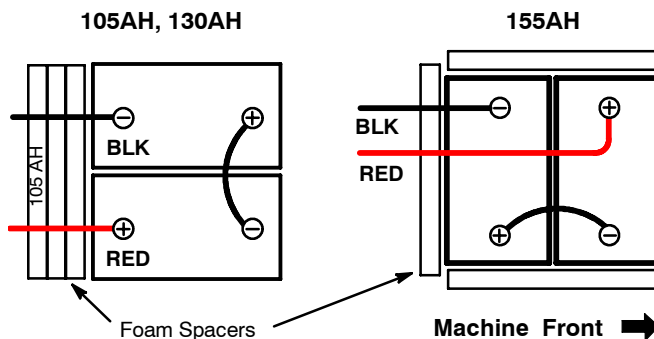

FIG. 2

**IMPORTANT: If your machine is equipped with the on-board battery charger, make sure that the charger is properly set for your battery type before charging (See USING THE ON-BOARD BATTERY CHARGER on page 16).**

---

## HOW THE MACHINE WORKS

---

### **Conventional Scrubbing:**

Water and detergent from the solution tank flow to the floor through a manually controlled solution valve. The brush uses the detergent and water solution to scrub the floor clean. As the machine moves forward, the squeegee wipes the dirty solution from the floor into the recovery tank.

### **Foam Scrubbing (FaST Model):**

#### **(FaST–Foam activated Scrubbing Technology)**

Unlike conventional scrubbing, the FaST system injects the FaST–PAK concentrate formula with a small amount of water and air onto the floor. The mixture creates a large volume of expanded wet foam for the brush to scrub the floor clean. As the machine moves forward, the foam collapses and the squeegee recovers the dirty solution into the recovery tank leaving the floor clean, dry and slip free.

### **ec-H2O Scrubbing (ec-H2O Model):**

#### **(ec-H2O–electrically converted water)**

Normal water passes through a module where it is oxygenated and charged with an electric current. The electrically converted water changes into a blended acidic and alkaline solution forming a neutral pH cleaner. The converted water attacks the dirt, breaks it into smaller particles, and pulls it off the floor surface allowing the machine to easily scrub away the suspended soil. The converted water then returns to normal water in the recovery tank.

---

## BRUSH AND PAD INFORMATION

---

For best results, use the correct brush type for the cleaning application. The following are recommended brushes and pads.

### ***Polypropylene Bristle Scrub Brush (Black) -***

Part No. 1016765 – 17 in / 43 cm

Part No. 1016811 – 20 in / 50 cm

This general purpose polypropylene bristle scrub brush is used for scrubbing lightly compacted soilage. This brush works well for maintaining concrete, wood and grouted tile floors.

### ***Soft Nylon Bristle Scrub Brush (White) -***

Part No. 1016764 – 17 in / 43 cm

Part No. 1016810 – 20 in / 50 cm

Recommended for cleaning coated floors without removing finish. Cleans without scuffing.

### ***Super Abrasive Bristle Scrub Brush (Gray) -***

Part No. 1016763 – 17 in / 43 cm

Part No. 1016805 – 20 in / 50 cm

Nylon fiber impregnated with abrasive grit to remove stains and soilage. Strong action on any surface. Performs well on buildup, grease, or tire marks.

### ***Polishing Pad (White) -***

Used to maintain highly polished or burnished floors.

### ***Buffing Pad (Red) -***

Used for light duty scrubbing without removing floor finish.

### ***Scrubbing Pad (Blue) -***

Used for medium to heavy-duty scrubbing. Removes dirt, spills, and scuffs and leaves surface clean ready for recoating.

### ***Stripping Pad (Brown) -***

Used for stripping of floor finish to prepare the floor for recoating.

### ***Heavy Duty Stripping Pad (Black) -***

Used for aggressive stripping of heavy finishes/sealers, or very heavy duty scrubbing.

***Surface Preparation Pad (Maroon)*** – This pad is for very aggressive floor stripping.



**MACHINE SETUP**

**ATTACHING SQUEEGEE ASSEMBLY**

1. Park the machine on a level surface, remove the key and set the parking brake if equipped.
2. Lift the squeegee lift lever to the upward position (Figure 3).



FIG. 3

3. Mount the squeegee assembly to the squeegee pivot bracket as shown (Figure 4). Make sure the knobs are completely seated into the slots before securing knobs.



FIG. 4

4. Connect the vacuum hose to the squeegee assembly. Loop the hose as shown using the hose clip provided (Figure 5).

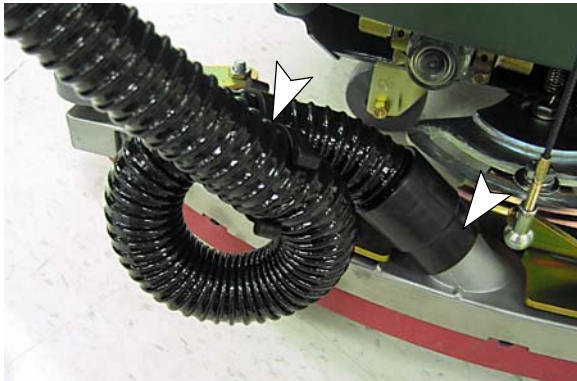

FIG. 5

5. Check the squeegee blades for proper adjustment (See *SQUEEGEE BLADE ADJUSTMENT* on page 23).

**INSTALLING BRUSH/PAD DRIVER**

**FOR SAFETY: Before installing brushes or pad drivers, stop machine on level surface, remove key and set parking brake if equipped.**

1. Park the machine on a level surface and remove the key.
2. Step down on the scrub head lift pedal to raise the scrub head off the floor (Figure 6).



FIG. 6

3. Attach the pad to the pad driver before installing pad driver (Figure 7). Secure pad with center lock.

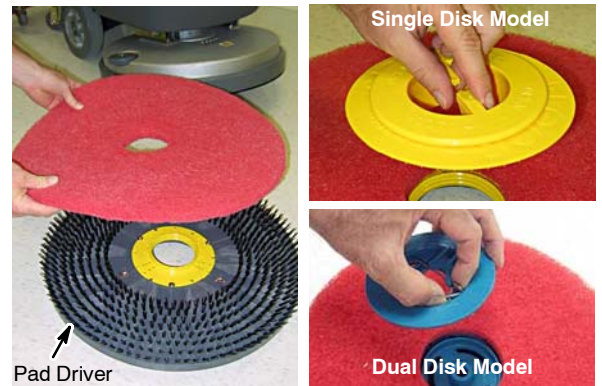

FIG. 7

## OPERATION

- Turn the brush motor hub until the slot with the spring clip is visible through the scrub head window (Figure 8).

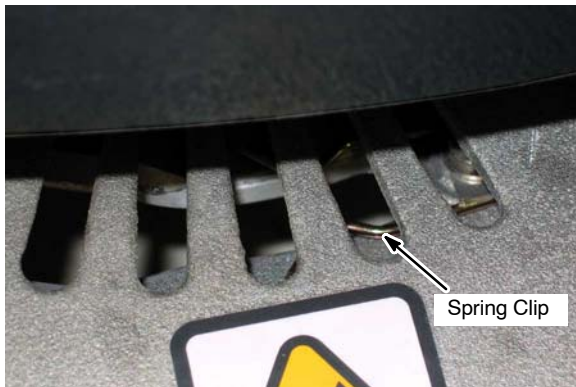

FIG. 8

- Align the pad driver mounting studs into the motor hub slots and give the pad driver a quick turn to engage spring clip (Figure 9). Single disk models: If necessary, press down on the motor hub lock pin to lock motor hub in place (Figure 10).

**NOTE:** For the dual disk model, the left and right pad drivers engage the spring clip in opposite directions.

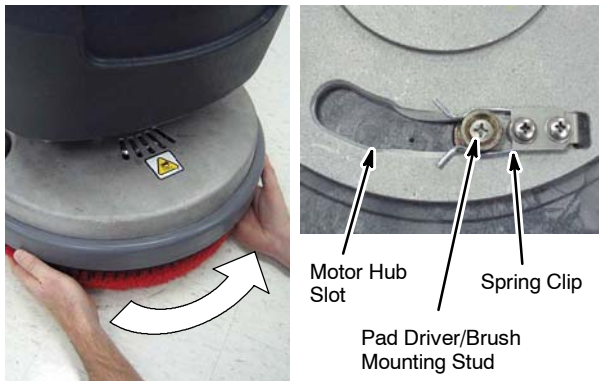

FIG. 9

- To remove the pad driver, grip the driver and give it a quick turn away from the spring clip.

Single Disk Models: Press down on the motor hub lock pin and turn the pad driver/brush clockwise (Figure 10).

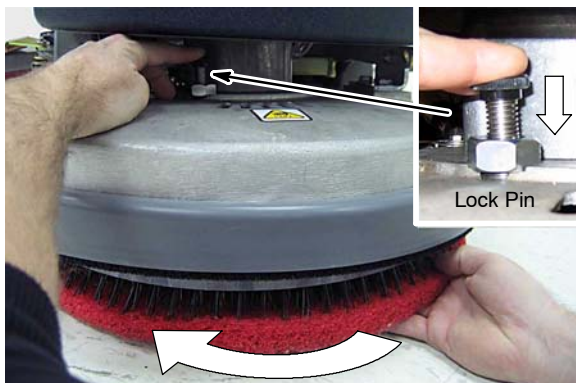

FIG. 10

## INSTALLING FaST-PAK CARTON (FaST Model)

**ATTENTION:** The FaST-PAK Concentrate Formula is specifically designed for the FaST system. NEVER use a substitute, machine damage may result.

- Remove the perforated knock-out from the FaST-PAK carton. Do not remove the bag from the carton. Pull the hose connector through the knock-out and remove the orange cap (Figure 11).

**FOR SAFETY:** When using machine, always follow the handling instructions on chemical container.



FIG. 11

- Lift the recovery tank to access the FaST-PAK compartment. Connect the supply hose to the FaST-PAK and place carton into the compartment as shown (Figure 12). Make sure that the supply hose doesn't get kinked or pinched.

**NOTE:** If any dried concentrate is visible on the supply hose connector or on the FaST-PAK connector, soak and clean with warm water.



FIG. 12

- When the supply hose is not in use, make sure to connect it to the storage plug (Figure 13). This will prevent the FaST system from drying out and clogging up the supply hose.



FIG. 13

### FILLING SOLUTION TANK

The machine is equipped with a hose fill-port at the rear of the machine, and a bucket fill-port located at the front of the machine (Figure 14).

Fill the solution tank to the “44 L MAX” level on the solution tank sight gauge (Figure 14).

**For Conventional Scrubbing:** Use hot water (60°C maximum). Pour a recommended cleaning detergent into the solution tank according to mixing instructions on the container.

**FOR FaST or ec-H<sub>2</sub>O SCRUBBING:** Use cool clean water only (<21°C). Do not add any conventional floor cleaning detergents, system failure may result.



FIG. 14

**NOTE:** When filling the solution tank with a bucket, make sure that the bucket is clean. Do not use the same bucket for filling and draining the machine.

**ATTENTION:** For Conventional Scrubbing, only use commercially approved cleaning detergents. Machine damage due to improper detergent usage will void the manufacturer’s warranty.

**⚠ WARNING: Fire or Explosion Hazard. Never Use Flammable Liquids.**

**FOR SAFETY:** When using machine, follow mixing and handling instructions on chemical containers.

### ADJUSTING CONTROL CONSOLE HEIGHT

Pull the control console height adjustment lever and lift or lower the console to a comfortable operating height. Release lever to lock in position (Figure 15).



FIG. 15

### MACHINE OPERATION

**FOR SAFETY: Do not operate machine, unless operator manual is read and understood.**

**⚠ WARNING: Fire Or Explosion Hazard. Never Operate Machine In Or Near Flammable Liquids, Vapors Or Combustible Dusts.**

#### PRE-OPERATION CHECKS

- Sweep and dust-mop the floor.
- Check the battery meter charge level (See BATTERY METER on page 14).
- Check the pad/brush for wear.
- Check the squeegee blades for wear and proper adjustment.
- Make sure the recovery tank is empty and the float shut-off screen is installed and clean.
- Check the scrub head skirt for wear.
- For FaST Scrubbing:** Check the FaST-PAK concentrate level.
- For FaST or ec-H<sub>2</sub>O Scrubbing:** Make sure the solution tank is filled with cool clean water only.
- For FaST or ec-H<sub>2</sub>O Scrubbing:** Ensure that all conventional cleaning agents are drained and rinsed from solution tank.

# OPERATION

## STARTING THE MACHINE

1. Release the parking brake if equipped (Figure 16).
2. Turn the main power key switch to the on ( I ) position (Figure 16).



FIG. 16

3. **FaST model:** Press the FaST system switch to the on ( I ) position (Figure 17).

**ec-H2O Model:** Press the ec-H2O system switch to the on ( I ) position (Figure 17).

**NOTE:** The ec-H2O system indicator light will not turn on until the machine starts scrubbing.

**IMPORTANT:** NEVER turn the FaST/ec-H2O system switch on when conventional scrubbing. Conventional cleaning detergents/restorers may cause failure to the FaST/ec-H2O solution system. Drain, rinse and refill solution tank with cool clean water before operating the FaST/ec-H2O system.



FIG. 17

4. Lower the squeegee assembly to floor by lowering the squeegee lift lever (Figure 18). *The vacuum motor will automatically turn on.*

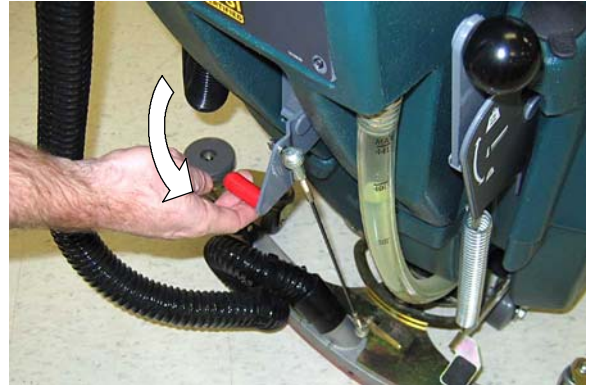

FIG. 18

5. Lower the scrub head to the floor by stepping on the scrub head lift pedal as shown (Figure 19).



FIG. 19

6. Pull the triggers to start scrubbing (Figure 20). The drive model will begin to propel forward. To reverse the drive model, simply pull the reverse trigger.

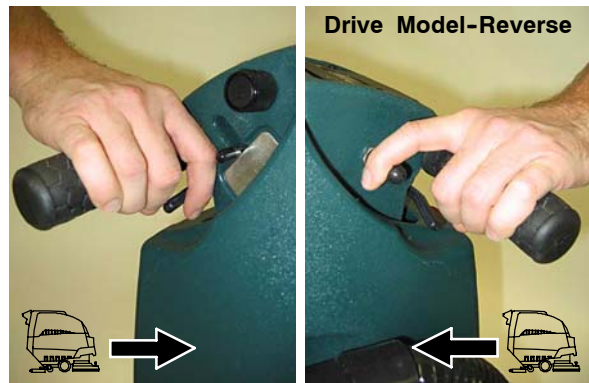

FIG. 20

7. Drive Model: Adjust the speed control knob to a desired scrubbing speed (Figure 21).

**NOTE:** 45–60 meters per minute is the recommended scrubbing speed.



FIG. 21

8. For conventional scrubbing, turn the solution flow control knob to a desired flow rate (Figure 22).

**NOTE:** For the FaST and ec-H2O models, the solution flow rate is fixed and requires no adjustment. The ec-H2O module has optional flow rate settings. If solution flow adjustments are required, contact an Authorized Service Center.



FIG. 22

9. When more brush pressure is needed for heavily soiled areas simply lift the down pressure lever (Figure 23).



FIG. 23

10. To stop scrubbing, release the triggers, raise the scrub head and the squeegee and turn the key to the off position.

### EMERGENCY STOP BUTTON (OPTION)

Strike the emergency stop button, if equipped, in the event of an emergency (Figure 24). This button shuts off all power to machine. Turn the button clockwise and restart the key to regain power .

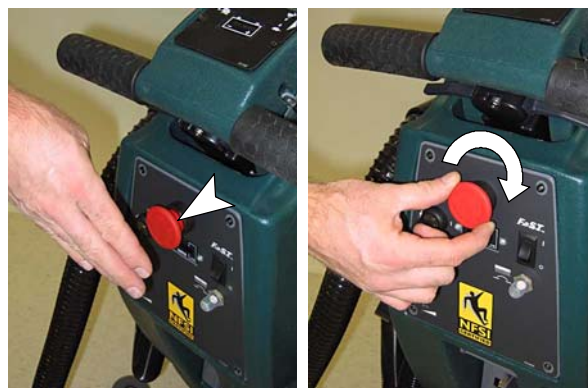

FIG. 24

### WHILE OPERATING MACHINE

**⚠ WARNING: Fire Or Explosion Hazard. Do Not Pick Up Flammable Materials Or Reactive Metals.**

**FOR SAFETY:** When using machine, go slow on inclines and slippery surfaces. Wear non-slip shoes.

1. Overlap each scrubbing path by 2 in / 5 cm.
2. Keep the machine moving to prevent damage to floor finish.
3. Wipe the squeegee blades with a cloth if blades leave streaks. Pre-sweep the area to prevent streaking.
4. Do not operate the machine on inclines that exceed 5% (3°).
5. Conventional scrubbing: Pour a commercially approved foam control solution into the recovery tank if excessive foam appears.

**ATTENTION:** Do not allow foam to enter the float shut-off screen, vacuum motor damage will result. Foam will not activate the float shut-off screen.

6. For heavily soiled areas, use the double scrubbing method. First scrub the area with the squeegee up, let solution set for 3–5 minutes, then scrub the area a second time with the squeegee down.
7. When leaving the machine unattended, remove the key and set the parking brake, if equipped.

# OPERATION

8. Drive Model: If the machine detects a fault, the battery meter will blink a fault code (See BATTERY METER LED FAULT CODES on page 29).
9. **ec-H2O Model:** If an alarm sounds and the ec-H2O system indicator light begins to blink red, the ec-H2O module must be flushed to resume ec-H2O operation (See ec-H2O MODULE FLUSH PROCEDURE) (Figure 25).

**NOTE:** When the alarm sounds and the light blinks red, the machine will bypass the ec-H2O system. To continue scrubbing, turn the ec-H2O switch off and change over to conventional scrubbing.

**ATTENTION: (ec-H2O model) Do not allow solution tank to run dry. ec-H2O module failure may result if operated without water for an extended period.**



FIG. 25

ec-H2O SYSTEM INDICATOR LIGHT CODE	CONDITION
Solid green	Normal operation
Blinking red	Flush ec-H2O module
Solid red	Contact Service Center

## BATTERY METER

The battery meter displays the charge level of the batteries. When the batteries are fully charged, all indicator lights will glow. As the batteries discharge, the indicator lights will begin to go out from right to left.

**NOTE:** To prolong the life of the batteries ONLY recharge the batteries when the machine is used for a total of 30 minutes or more.

**DRIVE MODEL:** When the discharge level reaches the first red light (Figure 26), stop scrubbing and recharge the batteries. If you continue to operate the machine beyond the first red light, the scrubbing function will automatically shut off when the last red light begins to blink. This protects the batteries from total discharge. Drive the machine to the charging area and recharge the batteries immediately.

**NOTE:** The Drive Model battery meter also displays machine fault codes. If a fault is detected the LED bars will flash specific fault codes (See BATTERY METER LED FAULT CODES on page 29).

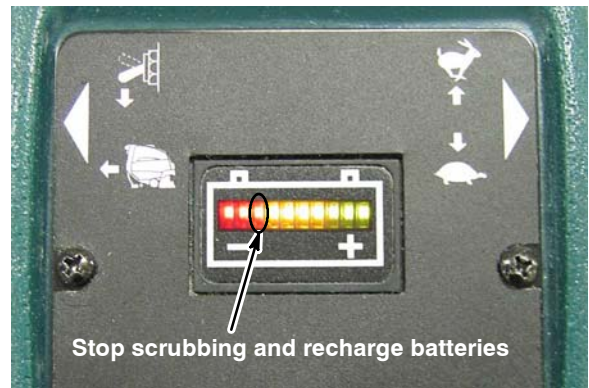

FIG. 26

**BRUSH ASSIST MODEL:** When the discharge level reaches the last yellow light (Figure 27), the light will begin to flash, stop scrubbing and recharge the batteries. If the red light appears, the scrubbing function will shut off automatically. This protects the batteries from total discharge. Recharge the batteries immediately.

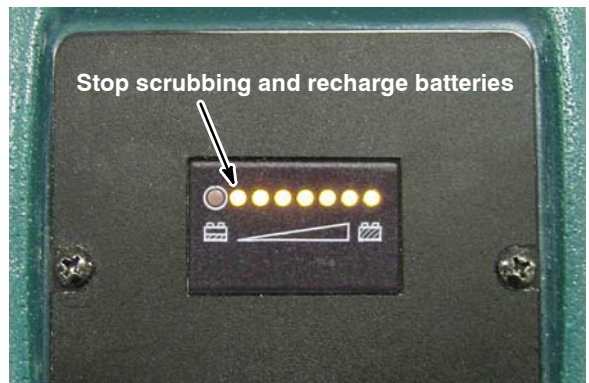

FIG. 27

### CIRCUIT BREAKER / FUSES

The machine is equipped with a resettable circuit breaker to protect the brush motor from damage. The circuit breaker button is located on the control panel (Figure 28). If the circuit breaker should trip, determine the cause, allow the motor to cool, and then manually reset the circuit breaker button.

The machine is also equipped with three fuses located inside the control console: 30A Main fuse (drive model), 5A Main fuse (brush assist model), 25A vacuum motor fuse and 7.5A FaST Pump/10A *ec-H2O* pump fuse. When replacing a fuse never substitute a higher Amp rated fuse than specified.

**Contact an Authorized Service Center for machine repairs.**

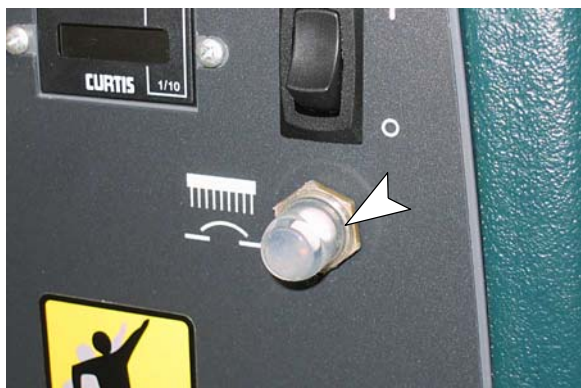

FIG. 28

### HOUR METER

The hour meter records the number of total hours the brush motor has been powered on. Use the hour meter to determine when to perform recommended maintenance procedures and to record service history (Figure 29).



FIG. 29

### DRAINING TANKS

After each use, the tanks should be drained and cleaned.

**FOR SAFETY: Before leaving or servicing machine, stop on level surface, turn off machine and remove key.**

#### DRAINING RECOVERY TANK

1. Transport machine to disposal area and turn key switch off.
2. While holding the drain hose upward, remove the cap and lower hose to drain (Figure 30).



FIG. 30

**NOTE:** When using a bucket to drain the machine, do not use the same bucket to fill the solution tank.

3. Remove the recovery tank cover and rinse out the tank (Figure 31).



FIG. 31

## OPERATION

4. Clean the float shut-off screen located in the recovery tank (Figure 32).



FIG. 32

## DRAINING SOLUTION TANK

To drain any remaining water from the solution tank, pull the solution tank level hose off the hose fitting (Figure 33).



FIG. 33

## CHARGING BATTERIES

The following charging instructions are intended for battery chargers supplied with the machine.

**ATTENTION:** To prolong the life of the batteries only recharge the batteries if the machine was used for a total of 30 minutes or more. Do not leave batteries discharged for lengthy periods.

**⚠ WARNING: Fire Or Explosion Hazard. Batteries Emit Hydrogen Gas. Keep Sparks and Open Flame Away. Keep Battery Compartment Propped Open When Charging.**

**FOR SAFETY:** When servicing batteries, wear protective gloves and eye protection when handling batteries and battery cables. Avoid contact with battery acid.

## BATTERY CHARGER SPECIFICATIONS:

- CHARGER TYPE:
  - FOR SEALED (Gel) BATTERIES
  - FOR WET (Lead Acid) BATTERIES
- OUTPUT VOLTAGE - 24 VOLTS
- OUTPUT CURRENT - 11 AMPS
- AUTOMATIC SHUTOFF CIRCUIT
- FOR DEEP CYCLE BATTERY CHARGING

## USING THE ON-BOARD BATTERY CHARGER

**IMPORTANT:** If your machine is equipped with the on-board battery charger, make sure the charger profile is properly set for your battery type before charging. Failure to properly set will result in battery damage.

To determine your battery type, see battery label. Contact your battery supplier if not specified.

To verify the setting of the charger profile, connect the charger cord into an electrical receptacle. If the LED labeled "GEL" is on, the charger is set for Gel (sealed) batteries. If the LED is off, the charger is set for Wet/lead acid (flooded) batteries (Figure 34).



FIG. 34



To change the charger profile, unplug the charger, remove the “Charger Profile Selection” panel and position the switch towards the proper setting, “GEL” or “Flooded” (Figure 35).

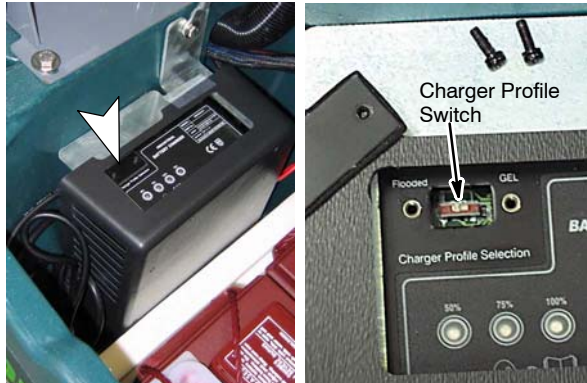

FIG. 35

1. Transport the machine to a well-ventilated area for charging.
2. Park the machine on a flat, dry surface. Turn the key off and set the parking brake, if equipped.
3. If charging wet (lead acid) batteries check the fluid level before charging (See BATTERY MAINTENANCE on page 24).
4. Connect the charger cord into a properly grounded electrical receptacle (Figure 36). The charger will start automatically within a few seconds. The LED's will display the charging state as described in the following table.

**NOTE:** The machine will not operate once the battery charger is connected.

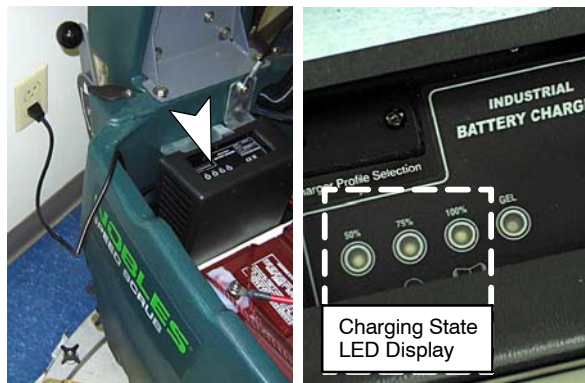

FIG. 36

CHARGING STATE LED DISPLAY			
Charging State	50% LED	75% LED	100% LED
0-50% charged	Blinking	Off	Off
50-75% charged	On	Blinking	Off
75-100% charged	On	On	Blinking
100% charged	On	On	On
Abnormal Cycle*	Off	Off	Blinking
Fault detected *	Blinking	Blinking	Blinking

\* See the On-board Battery Charger Fault Codes table. When a fault occurs, the charger will also sound an alarm.

5. Prop up the recovery tank for ventilation when charging (Figure 37).



FIG. 37

6. Once the batteries are fully charged, the charger will stop supplying power, but will continue to monitor the battery voltage. The charger will restart if the batteries self-discharge.

**NOTE:** The charger may take up to 30 seconds to turn off once the charger cord is disconnected. During this time, the machine will not power up.

The charger cord must also be disconnected for 30 seconds before the charger can be restarted.

# OPERATION

## ON-BOARD BATTERY CHARGER FAULT CODES

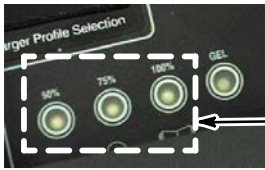

Blinking LED's

LED FAULT CODE	FAULT	SOLUTION
3 LED's blink once repeatedly	Loose charger cable connection.	Check charger cable connection.
	Loose or damaged battery cable.	Check battery cable connections.
	Defective Battery.	Replace battery.
3 LED's blink twice repeatedly	Input voltage is out of range.	Try using a different wall outlet.
3 LED's blink three times repeatedly	Safety thermostat exceeded maximum internal temperature.	Open battery compartment to promote air circulation or move machine to a cooler climate.
3 LED's blink four times repeatedly	Output current exceeds a limit.	Disconnect charger cord, wait 30 seconds, then plug back in. If fault continues replace charger or Contact Service Center.
100% LED blinks while the 50% and 75% LED's are off.	Abnormal cycle. Safety timer exceeded the 18 hour charging time.	Battery maintenance required or replace battery.

## USING THE OFF-BOARD BATTERY CHARGER

For battery charger operating instructions, refer to the Battery Charger Manual supplied with charger.

1. Transport the machine to a well-ventilated area.

**⚠ WARNING: Fire Or Explosion Hazard. Batteries Emit Hydrogen Gas. Keep Sparks And Open Flame Away. Keep Battery Compartment Open When Charging.**

2. Park the machine on a flat, dry surface. Turn the key off and set the parking brake, if equipped.
3. If charging wet (lead acid) batteries, check the fluid level before charging (See BATTERY MAINTENANCE on page 25).
4. Prop up the recovery tank for ventilation when charging (Figure 38).



FIG. 38

5. Connect the charger's AC power supply cord to a properly grounded receptacle.
6. Connect the charger's DC cord to the machine's battery receptacle at the rear of the machine (Figure 39).

**NOTE:** The machine will not operate once the battery charger is connected.



FIG. 39

**ATTENTION:** Do not disconnect the charger's DC cord from the machine's receptacle when the charger is operating. Arcing may result. If the charger must be interrupted during charging, disconnect the AC power supply cord first.

## MACHINE MAINTENANCE

To keep the machine in good working condition, simply follow the daily, monthly and quarterly maintenance procedures.

**⚠ WARNING: Electrical Hazard. Disconnect Battery Cables Before Servicing Machine.**

### DAILY MAINTENANCE (After Every Use)

1. Drain and rinse out the recovery tank (Figure 40).



FIG. 40

2. Remove and clean the float shut-off screen located in the recovery tank (Figure 41).



FIG. 41

## OPERATION

3. Drain the solution tank and rinse out the inside with hot water, 60°C maximum temperature, as needed (Figure 42)

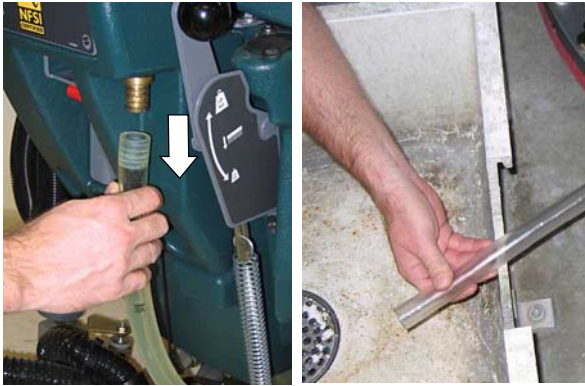

FIG. 42

4. Remove the pad/brush and clean. Rotate pad or replace when worn (Figure 43).

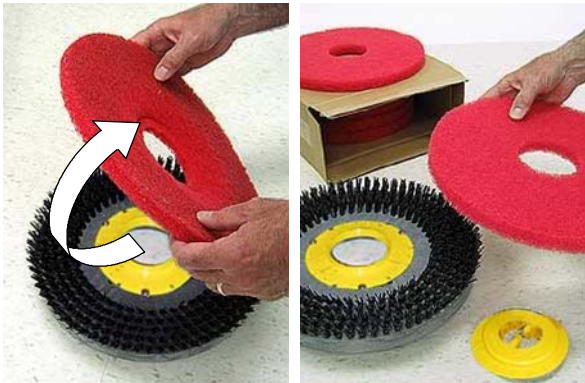

FIG. 43

5. Wipe the squeegee blades clean (Figure 44). Store the squeegee assembly in the raised position to prevent blade damage.

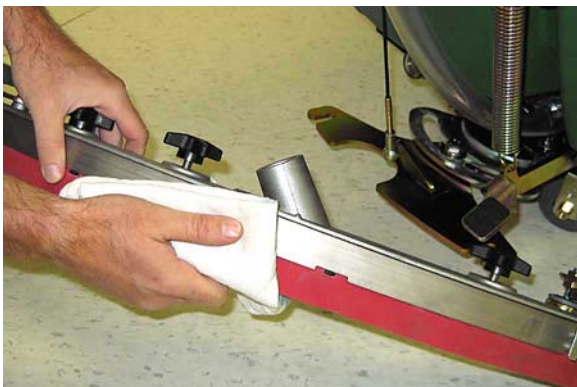

FIG. 44

6. Check the condition of the squeegee blade wiping edge (Figure 45). Rotate blade if worn (See SQUEEGEE BLADE REPLACEMENT on page 23).



FIG. 45

7. Clean the machine with an all purpose cleaner and damp cloth (Figure 46).

**FOR SAFETY: When cleaning machine, do not power spray or hose off machine. Electrical malfunction may occur.**



FIG. 46

8. Inspect the condition of the scrub head skirt, replace if worn or damaged (Figure 47).



FIG. 47

9. FaST Model: Connect the FaST-PAK supply hose to the storage plug when not in use (Figure 48). Remove any dried concentrate from the hose connector by soaking it in warm water.



**FIG. 48**

10. Recharge the batteries. To prolong the life of the batteries, only recharge the batteries if machine was used for a total of 30 minutes or more (Figure 49).



**FIG. 49**

**MONTHLY MAINTENANCE**

1. Remove the solution tank filter from underneath the machine and rinse out the screen (Figure 50). Make sure the solution tank is empty before removing filter.



**FIG. 50**

2. Clean the battery tops to prevent corrosion (See BATTERY MAINTENANCE on page 24).

3. Check for loose battery cable connections.
4. Inspect and clean the recovery tank cover seal (Figure 51). Replace if damaged.



**FIG. 51**

5. Lubricate all pivot points and rollers with a water resistant grease.
6. If equipped, clean the parking brake clamp with a cleaning solvent.
7. Check the machine for loose nuts and bolts.
8. Check the machine for leaks.

**MOTOR MAINTENANCE**

**Contact an Authorized Tennant Service Center for carbon brush replacement.**

Carbon Brush Replacement	Hours
Drive Transaxle Motor	750
Vacuum Motor	750
Brush Motor	750

**⚠ WARNING: Electrical Hazard. Disconnect Battery Cables Before Servicing Machine.**

# OPERATION

## FaST SYSTEM MAINTENANCE

Every 1000 hours replace the water filter and air filter located in the FaST detergent injector. Order filter kit p/n 9003009.

1. To access the detergent injector assembly, lower the scrub head and remove the front shroud. (Figure 52).



FIG. 52

2. Remove the injector assembly from clamps (Figure 53).



FIG. 53

3. Replace the water and air filter. An 8mm hex wrench required to install new water filter (Figure 54).

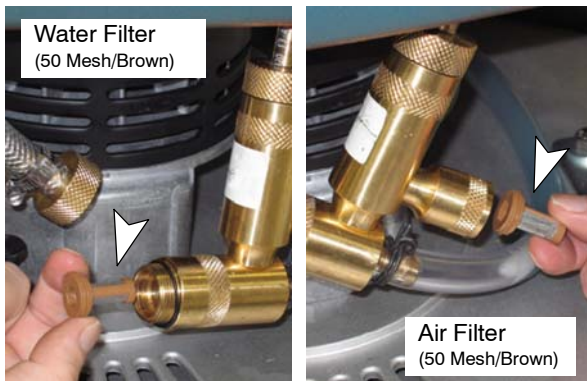

FIG. 54

## ec-H2O MODULE FLUSH PROCEDURE

This procedure is only required when an alarm sounds and the ec-H2O system indicator light begins to blink red.

1. Drain the solution tank and recovery tank of all water.
2. Pour 1 gallon (4 liters) of white or rice vinegar into the solution tank at full strength. Do not dilute.

**NOTE:** Use *white or rice vinegar* only. The acidity level should be between 4-8%. Do not use other acids for this procedure.

**FOR SAFETY:** When servicing machine, wear protective gloves and eye protection when handling vinegar.

3. Disconnect the black connector fitting at the scrub head and place the hose into a bucket (Figure 55). To access the connector fitting, you may have to remove the front cover from the machine.



FIG. 55

4. Turn the key to the on ( I ) position.

5. Press and release the *ec-H2O* module flush switch to start the flush cycle (Figure 56). The module is located under the recovery tank.

**NOTE:** The module will automatically shut off when the flush cycle is complete (approx. 7 minutes). The module must run the full 7 minute cycle in order to reset the system indicator light and alarm.

Repeat flush procedure if the *ec-H2O* module does not reset. If module fails to reset, contact an Authorized Service Center.



FIG. 56

### SQUEEGEE BLADE REPLACEMENT

Each squeegee blade has four wiping edges. When the blades become worn, simply rotate the blades end-for-end or top-to-bottom for a new wiping edge. Replace blade if all four edges are worn.

1. Remove the squeegee assembly from the machine.
2. Loosen the band clamp and remove the band from the squeegee assembly (Figure 57).

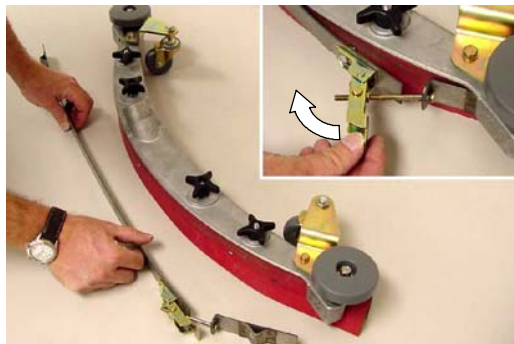

FIG. 57

3. Rotate the rear blade to a new wiping edge and reinstall the band. Make sure the notched edge of the band is facing downward (Figure 58).

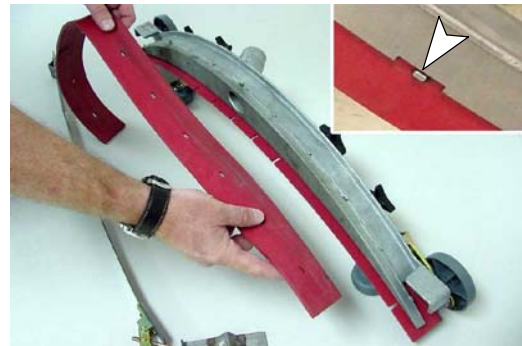

FIG. 58

4. To replace the front blade, remove the rear band and fully loosen the four squeegee assembly knobs, do not remove the knobs. Lift and tilt the retainer plate to access the front blade (Figure 59). Rotate the front blade to a new wiping edge and return the retainer plate. Make sure the retainer plate tabs engage the blade slots. Reinstall the band then retighten the knobs.

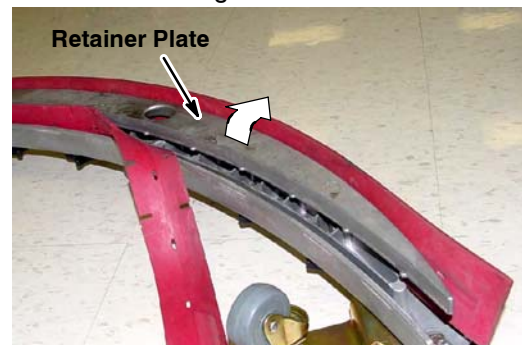

FIG. 59

# OPERATION

## SQUEEGEE BLADE ADJUSTMENT

The adjustment of the squeegee blades are factory set and require no further adjustment. Squeegee adjustment is only necessary if it comes out of adjustment.

For optimum squeegee blade performance, the squeegee assembly casters must be adjusted to a specified height as described below.

1. To check the squeegee assembly for proper adjustment, remove the squeegee assembly from the machine and place it on a level surface. Measure the distance between the caster and the surface. It should measure approximately 1/16 in / 2 mm (Figure 60).
2. To adjust the caster height, loosen the top nut and remove the plastic bearing cover to access the adjustment nut. Turn the adjustment nut until properly adjusted (Figure 60). After adjusting, tighten the top nut and replace the plastic bearing cover. Repeat step for the other caster.

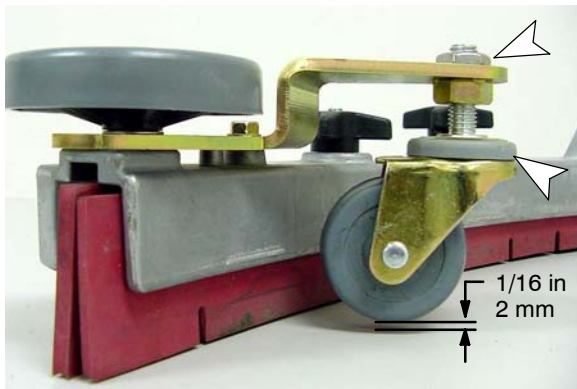

FIG. 60

3. During machine operation, with the casters properly adjusted, the squeegee blades should deflect as shown (Figure 61).



FIG. 61

## BATTERY MAINTENANCE (Wet/lead acid batteries)

1. Check battery fluid level frequently to prevent battery damage. The fluid should be at the level shown (Figure 62). Add distilled water if low. **DO NOT OVERFILL**, the fluid may expand and overflow when charging.

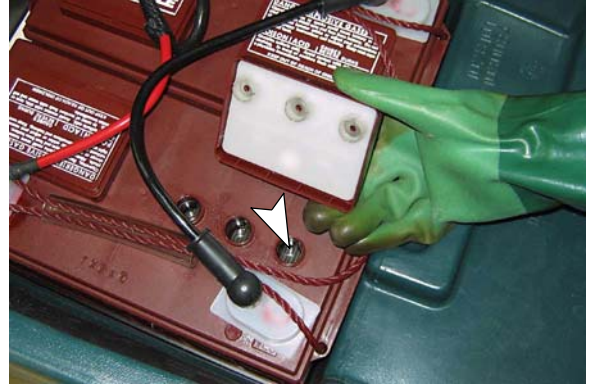

### CORRECT BATTERY FLUID LEVEL:

Before Charging

After Charging

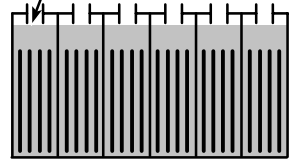
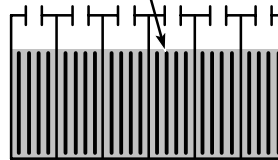

FIG. 62

**⚠ WARNING: Fire Or Explosion Hazard. Batteries Emit Hydrogen Gas. Keep Sparks And Open Flame Away. Keep Battery Compartment Open When Charging.**

2. Clean the batteries to prevent battery corrosion. Use a scrub brush with a mixture of baking soda and water (Figure 63).

**FOR SAFETY: When cleaning batteries, wear protective gloves and eye protection. Avoid contact with battery acid.**



FIG. 63

3. Check for loose or worn cables. Replace if worn.



**BRUSH MOTOR BELT REPLACEMENT  
(DUAL DISK MODEL)**

**⚠ WARNING: Electrical Hazard. Disconnect Battery Cables Before Servicing Machine.**

- Using a 13 mm wrench, disconnect the scrub head lift arms from the scrubhead mounting brackets as shown (Figure 64).

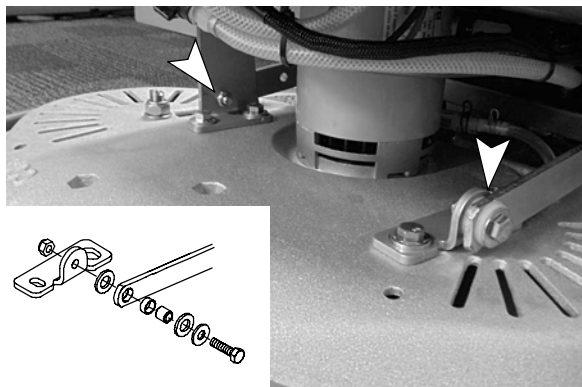

FIG. 64

- Unplug the brush motor wire connector and disconnect the solution feed hose (Figure 65).

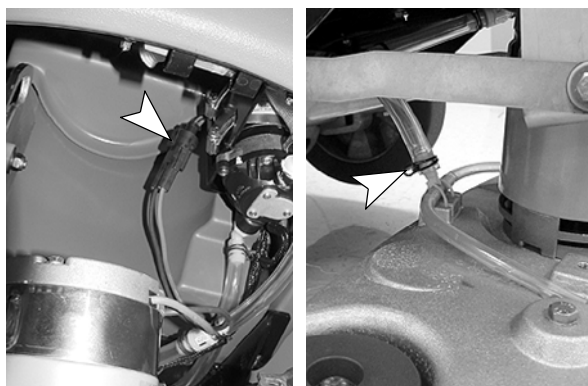

FIG. 65

- Remove the scrub head from the machine (Figure 66).

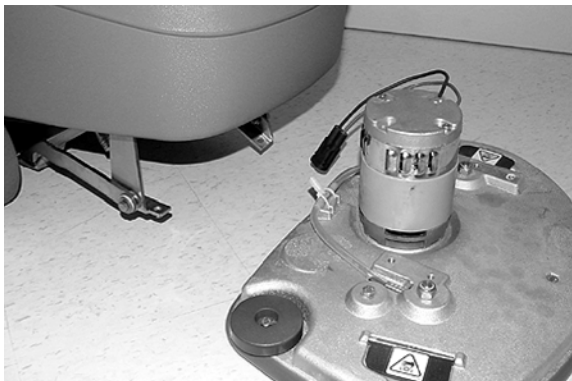

FIG. 66

- Carefully lay the scrub head bottom side up and remove the belt cover, 10 mm wrench required (Figure 67).

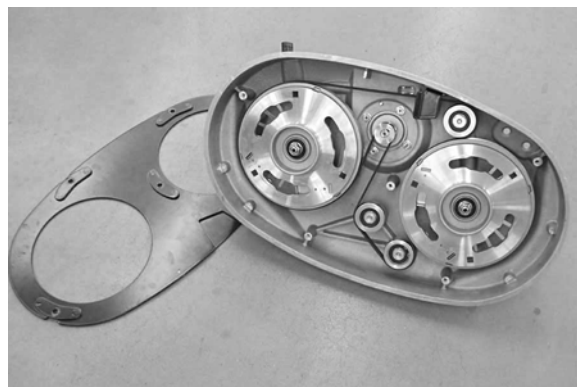

FIG. 67

- Route the new belt as shown (Figure 68).

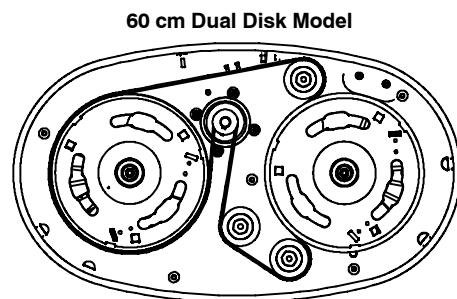

FIG. 68

- To install belt, use a socket driver ratchet with an extension and a large flathead screwdriver as shown. The hub driver is equipped with tool slots (Figure 69).

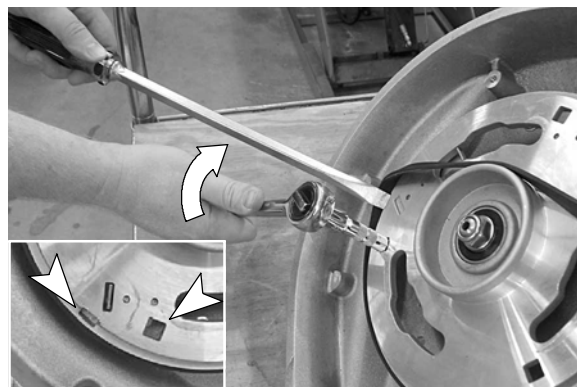

FIG. 69

## OPERATION

---

### TRANSPORTING MACHINE

---

When transporting the machine by trailer or truck, be certain to follow the transporting procedure below:

1. Drain machine tanks.
2. Raise the squeegee and scrub head.
3. Load the machine using a ramp that can support the machine weight and person loading it. The maximum ramp incline should not exceed 11° at a ramp length of 12 ft (3.7m).
4. Position the front of machine up against the front of the trailer or truck. Lower the scrub head and squeegee.
5. Place a block behind each wheel to prevent the machine from rolling.
6. Secure with tie-down straps as shown (Figure 70). It may be necessary to install tie-down brackets to trailer or truck.

**FOR SAFETY: When loading/unloading machine onto/off truck or trailer, use a ramp that can support the machine weight and person loading it, do not exceed a 11° ramp incline at a ramp length of 12 ft (3.7m), use tie-down straps to secure machine and block machine wheels.**

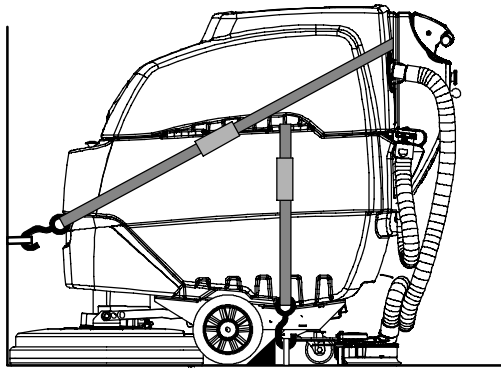

FIG. 70

---

### STORING MACHINE

---

1. Charge the batteries before storing. Never store the machine with discharged batteries.
2. Drain and rinse the tanks thoroughly.
3. Store the machine in a dry area with the squeegee and scrub head in the up position.
4. Open the recovery tank cover to promote air circulation.

**ATTENTION: Do not expose machine to rain, store indoors.**

5. If storing machine in freezing temperatures, follow the FREEZE PROTECTION instructions below.

---

### FREEZE PROTECTION

1. Drain the solution tank and recovery tank of all water.
2. Empty the solution tank filter located under the machine (Figure 71).



FIG. 71

3. Pour 1 gallon (4 liters) of recreational vehicle (RV) antifreeze into the solution tank at full strength. Do not dilute.

**FOR SAFETY: Avoid eye contact with antifreeze. Wear safety glasses.**

4. Turn the machine power on and operate the solution flow system. Turn the machine off when the red RV antifreeze is visible.

If your machine is equipped with the off-aisle wand option, operate the the off-aisle wand for a few seconds to protect the pump.

Continue with the freeze protection procedure if machine is equipped with the *FaST* or *ec-H2O* system.

#### ***ec-H2O* Model:**

Press and release the flush switch on the *ec-H2O* module to cycle the antifreeze through *ec-H2O* system (Figure 72). When the antifreeze is visible, press the switch again to turn off the module.



FIG. 72

**IMPORTANT:** Before operating machine the antifreeze must be flushed from the module as described below.

If the antifreeze is not properly flushed from the *ec-H2O* system, the *ec-H2O* module may detect an error and not function (*ec-H2O* switch indicator light will turn red). If this occurs, reset key and repeat the flush procedure as described below.

**Flushing antifreeze from *ec-H2O* module:**

1. Drain the antifreeze from the solution tank into a bucket.
2. Fill the solution tank with cool water until full (See FILLING SOLUTION TANK).
3. Disconnect the black connector fitting at the scrub head and place the hose into a bucket (Figure 73). To access the connector fitting, you may have to remove the front cover from the machine.



FIG. 73

4. Press and release the *ec-H2O* module switch to flush the antifreeze from the *ec-H2O* system (Figure 65). The module is located under the recovery tank.

When the water turns clear, press the module switch again to stop the flush cycle.

Dispose the antifreeze in an environmentally safe way according to local waste disposal regulations.

5. The machine is now ready for scrubbing.

**FaST Model:**

The following items are required: valve coupling #1006205 and 6 in / 15 cm Hose #63182.

1. Remove the FaST-PAK carton and connect the valve coupling and 6 in / 15 cm hose to the FaST detergent supply hose (Figure 74).

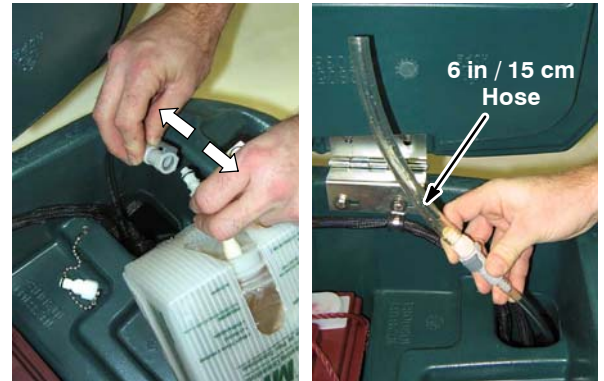

FIG. 74

2. Disconnect the opposite end of the FaST supply hose from the injector assembly and drain the detergent from the hose (Figure 75). Reconnect the hose after draining. To access the injector assembly remove the front cover.



FIG. 75

## OPERATION

3. Pour the recreational vehicle (RV) antifreeze into the supply hose until full (Figure 76).
4. Keep the hose upright to prevent the Anti-freeze from spilling and lower the recovery tank.



FIG. 76

5. Operate the FaST system until the foaming stops. This step could take anywhere from 5-10 minutes.

6. When finished, connect the supply hose to the storage plug (Figure 77).

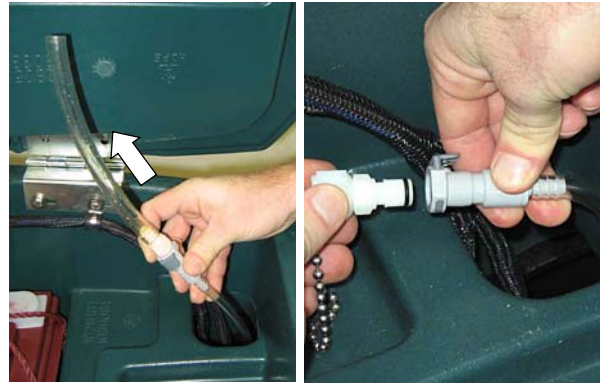

FIG. 77

7. To drain the antifreeze from the FaST supply hose, repeat steps 1 and 2.

## RECOMMENDED STOCK ITEMS

Refer to the Parts List manual that is supplied with each machine for recommended stock items. Stock Items are clearly identified with a bullet preceding the parts description. See example below:

26	1017380	(00000000-	)	• Hose, Drain, Assy, 1.5d X 29.5l, Blk,Flx
27	1008639	(00000000-	)	• Drain Assy
28	1019563	(00000000-	)	• Strap, Drain Cap
29	1008637	(00000000-	)	• O Ring, 1.48" Id, 1.76" Od

**TROUBLESHOOTING**

PROBLEM	CAUSE	SOLUTION
Machine will not operate	Triggers not pulled	Pull triggers
	Emergency-stop button activated	Turn button clockwise to reset
	Discharged batteries	Charge batteries
	Faulty battery(s)	Replace battery(s)
	Loose battery cable	Tighten loose cable
	Main fuse blown	Replace fuse
	Faulty key switch	Contact Service Center
	Machine fault detected (Drive model)	See Battery Meter LED Fault Codes
On-board battery charger will not operate	Plug not connected to power supply	Check plug connection
	Faulty power supply cord	Replace cord
	Fault detected.	See On-board Battery Charger Fault Codes
Brush motor will not operate	Scrub head is raised off floor	Lower scrub head
	Battery meter lockout activated	Recharge batteries
	Tripped brush motor circuit breaker	Reset brush circuit breaker button
	Faulty scrub head (up/down) switch	Contact Service Center
	Faulty triggers	Contact Service Center
	Faulty brush motor or wiring	Contact Service Center
	Worn motor carbon brushes	Contact Service Center
	Broken or loose belt (24" Dual Disk model)	Replace belt
Machine does not propel (Drive model)	Main fuse blown	Replace 30 Amp fuse
	Faulty relay switch	Contact Service Center
	Faulty transaxle motor or wiring	Contact Service Center
	Worn motor carbon brushes	Contact Service Center
Vacuum motor will not operate	Squeegee is raised off floor	Lower squeegee
	Vacuum motor fuse blown	Replace 25 Amp fuse
	Faulty vacuum motor or wiring	Contact Service Center
	Worn motor carbon brushes	Contact Service Center
FaST Model: FaST System does not operate or operate correctly	FaST system switch is not turned on	Turn on FaST system switch
	FaST-PAK supply hose not connected	Connect supply hose
	FaST Pump fuse blown	Replace 7.5 Amp fuse
	Clogged FaST-PAK supply hose or connectors	Soak in warm water to unclog
	Empty FaST-PAK carton	Replace FaST PAK carton
	Kink in FaST-PAK supply hose	Undo hose kink
	Clogged FaST solution system	Contact Service Center
	Faulty FaST system on/off switch	Contact Service Center
	Faulty pump	Contact Service Center
	Clogged solution tank filter	Drain solution tank. remove solution tank filter, clean and reinstall

## OPERATION

### TROUBLESHOOTING - Continued

PROBLEM	CAUSE	SOLUTION
FaST Model: FaST System does not operate or operate correctly	Clogged orifice/filter screen	Replace orifice/filter screen (See FaST SYSTEM MAINTENANCE)
Little or no solution flow (Conventional Scrubbing)	Clogged solution tank filter or solution hose	Clean solution tank filter or flush out solution hose
	Clogged solution valve	Remove valve and clean
	Solution flow control knob set too low	Adjust solution control flow knob
	Loose screw on control knob	Calibrate knob and retighten screw
Poor water pickup	Recovery tank is full	Drain recovery tank
	Loose drain hose cap	Tighten cap
	Clogged float shut-off screen located in recovery tank	Clean screen
	Clogged squeegee assembly	Clean squeegee assembly
	Worn squeegee blades	Replace or rotate squeegee blades
	Incorrect Squeegee blade deflection	Adjust Squeegee blade height
	Loose vacuum hose connections	Secure hose connections
	Clogged vacuum hose	Remove clogged debris
	Damaged vacuum hose	Replace vacuum hose
	Recovery tank cover not in place	Properly position cover
	Damaged recovery tank cover seal	Replace seal
	Faulty vacuum motor	Contact Service Center
	Low battery charge	Recharge batteries.
Short run time	Low battery charge	Fully recharge batteries
	Defective batteries	Replace battery
	Batteries need maintenance	See BATTERY MAINTENANCE
	Faulty battery charger	Repair or replace battery charger
	Brush pressure lever is set for extra scrub head pressure	Lower brush pressure lever

**TROUBLESHOOTING - Continued**

PROBLEM	CAUSE	SOLUTION
<b>ec-H2O Model:</b> <i>ec-H2O</i> system indicator light blinks red and alarm sounds	Mineral deposit build-up in module	Flush module (See <i>ec-H2O</i> MODULE FLUSH PROCEDURE). If indicator light starts flashing within 1–10 seconds, repeat flush procedure. If indicator light starts flashing after a minute of scrubbing, the water may have low conductivity.
	Low water conductivity	Add 8 ml of salt to every 40 L of water.
<b>ec-H2O Model:</b> <i>ec-H2O</i> system indicator light solid red	Defective module	Contact Service Center
<b>ec-H2O Model:</b> <i>ec-H2O</i> system indicator light does not turn on	Defective light or module	Contact Service Center
<b>ec-H2O Model:</b> No water flow	Clogged module	Contact Service Center
	Defective solution pump	Replace solution pump

**BATTERY METER LED FAULT CODES (Drive Model Battery Meter Display)**

CODE (Flashing LED Bars)	FAULT	SOLUTION
One	Low voltage shut-off. Scrubbing function stops.	Recharge batteries. Check battery connection.
	Battery charge level getting low.	Recharge batteries.
Three	Drive motor tripped.	Remove overload condition and reset key.
	Short circuit to drive motor.	Contact Service Center.
Four	Battery lockout.	Recharge batteries immediately.
Eight	Controller tripped.	Contact Service Center.
Ten	High battery voltage reading	Check battery connections.
No Bars	Sleep mode	Turn key to restore.
Bars Rippling	Throttle engaged.	Release triggers

# OPERATION

## MACHINE SPECIFICATIONS

MODEL	17 in / 43 cm Brush Assist	20 in / 50 cm Brush Assist	20 in / 50 cm w/ Drive	24 in / 60 cm Dual Disk
LENGTH	48 in / 1,219 mm	50.25 in / 1,276 mm	50.25 in / 1,276 mm	48.25 in / 1,225 mm
WIDTH	20 in / 507 mm	21.5 in / 549 mm	21.5 in / 549 mm	26 in / 660 mm
HEIGHT	43 in / 1093 mm	43 in / 1093 mm	43 in / 1093 mm	43 in / 1093 mm
MINIMUM AISLE TURN	49.5 in / 1,257 mm	51.5 in / 1,308 mm	51.5 in / 1,308 mm	54 in / 1,370 mm
WEIGHT	203 lb / 92 kg	205 lb / 93 kg	216 lb / 98 kg	216 lb / 98 kg
WEIGHT WITH BATTERIES	315 lb / 143 kg	340 lb / 154 kg	386 lb / 175 kg	386 lb / 175 kg
RECOVERY TANK CAPACITY Includes Demisting Chamber	15 gal / 57 L	15 gal / 57 L	15 gal / 57 L	15 gal / 57 L
SOLUTION TANK CAPACITY	10.5 gal / 40 L	10.5 gal / 40 L	10.5 gal / 40 L	10.5 gal / 40 L
DRIVE SYSTEM	Brush Assisted	Brush Assisted	Transaxle, 24 V, .14 hp / .104 kW	Transaxle, 24 V, .14 hp / .104 kW
TRAVEL SPEED, MAXIMUM	n/a	n/a	240 ft / 73 m /min	240 ft / 73 m /min
PRODUCTIVITY RATE Estimated Actual	8,440 ft <sup>2</sup> / 785 m <sup>2</sup> h	10,125 ft <sup>2</sup> / 940 m <sup>2</sup> h	13,050 ft <sup>2</sup> / 1,250 m <sup>2</sup> h	n/a
CLEANING PATH WIDTH	17 in / 430 mm	20 in / 500 mm	20 in / 500 mm	24 in / 600 mm
BRUSH PRESSURE	50 lb / 22.7 kg Min 90 lb / 40.8 kg Max	50 lb / 22.7 kg Min 90 lb / 40.8 kg Max	50 lb / 22.7 kg Min 90 lb / 40.8 kg Max	50 lb / 22.7 kg Min 90 lb / 40.8 kg Max
SOLUTION FLOW RATE	.4 gpm / 1.5 L/min	.4 gpm / 1.5 L/min	.4 gpm / 1.5 L/min	.4 gpm / 1.5 L/min
SQUEEGEE WIDTH	30 in / 763 mm	30 in / 763 mm	30 in / 763 mm	30 in / 763 mm
BRUSH MOTOR	1.0. hp / .746 kW, 200 rpm, 24 V, 42 A			
VACUUM MOTOR	.5 hp / .373 kW, 300 W, 2-stage 5.7, 24 V, 13 A			
WATER LIFT - AIR FLOW	40 in / 1,016 mm - 65 ft <sup>3</sup> / 1.84 L <sup>3</sup> /m			
BATTERIES	Qty 2, 12 V	Qty 2, 12 V	Qty 2, 12 V	Qty 2, 12 V
BATTERY CAPACITY	105 Ah @ 20 h rate (WET)	130 Ah @ 20 h rate (WET)	155 Ah @ 20 h rate (WET)	155 Ah @ 20 h rate (WET)
RUN TIME PER CHARGE*	2.5 Hours	2.5 Hours	3.0 Hours	3.0 Hours
ON-BOARD BATTERY CHARGER	120/230 VAC, 5.5 A, 50/60 Hz, 24 VDC, 11 A output			
TOTAL POWER CONSUMPTION	28 A nominal @ 50 lb / 22.7 kg brush pressure	29 A nominal @ 50 lb / 22.7 kg brush pressure	30 A nominal @ 50 lb / 22.7 kg brush pressure	29 A nominal @ 50 lb / 22.7 kg brush pressure
	34 A nominal @ 90 lb / 40.8 kg brush pressure	35 A nominal @ 90 lb / 40.8 kg brush pressure	36 A nominal @ 90 lb / 40.8 kg brush pressure	36 A nominal @ 90 lb / 40.8 kg brush pressure
VOLTAGE DC	24 VDC	24 VDC	24 VDC	24 VDC
PROTECTION GRADE	IPX3	IPX3	IPX3	IPX3
DECIBEL RATING AT OPERATOR'S EAR, INDOORS.**	68.5 dBA	68.5 dBA	68.5 dBA	68.5 dBA
VIBRATION AT CONTROLS	<8.2 ft/s <sup>2</sup> / <2.5 m/s <sup>2</sup>	<8.2 ft/s <sup>2</sup> / <2.5 m/s <sup>2</sup>	<8.2 ft/s <sup>2</sup> / <2.5 m/s <sup>2</sup>	<8.2 ft/s <sup>2</sup> / <2.5 m/s <sup>2</sup>
GRADE LEVEL, MAX.	Scrubbing 5% (3°), Transporting 8% (5°)			

\* Run times are based on Continuous Scrubbing Run Times.

\*\* Sound levels (ISO 11201) as recommended by the American Association of Cleaning Equipment Manufacturers (AACEM) and OSHA.



<b>FaST SYSTEM MODEL</b>	<b>17 in / 43 cm Brush Assist</b>	<b>20 in / 50 cm Brush Assist</b>	<b>20 in / 50 cm w/ Drive</b>	<b>24 in / 60 cm Dual Disk</b>
<b>PRODUCTIVITY RATE</b> Estimated Actual	11,250 ft <sup>2</sup> / 1,045 m <sup>2</sup> /h	13,500 ft <sup>2</sup> / 1,255 m <sup>2</sup> /h	15,300 ft <sup>2</sup> / 1,420 m <sup>2</sup> /h	18,150 ft <sup>2</sup> / 1,690 m <sup>2</sup> /h
<b>SOLUTION PUMP</b>	24 Volt DC, 3.5 A, 1.5 gpm / 5.6 L/min open flow, 60 psi / 4.13 Bar bypass setting			
<b>SOLUTION FLOW RATE</b>	0.12 gpm / 0.47 L/min			
<b>CONCENTRATE FLOW RATE</b>	0.016 oz / 0.47 CC /min.			
<b>CONCENTRATE TO WATER DILUTION RATIO</b>	1:1000			
<b>ec-H2O SYSTEM MODEL</b>				
<b>PRODUCTIVITY RATE</b> Estimated Actual	11,250 ft <sup>2</sup> / 1,045 m <sup>2</sup> /h	13,500 ft <sup>2</sup> / 1,255 m <sup>2</sup> /h	15,300 ft <sup>2</sup> / 1,420 m <sup>2</sup> /h	18,150 ft <sup>2</sup> / 1,690 m <sup>2</sup> /h
<b>SOLUTION PUMP</b>	24 Volt DC, 3.5 A, 5.6 LPM open flow, 4.13 Bar bypass setting			
<b>SOLUTION FLOW RATE*</b>	0.12 gpm / 0.47 L/min (standard)			0.15 gpm / 0.57 L/min (standard)
	0.19 gpm / 0.72 L/min (optional)			0.20 gpm / 0.76 L/min (optional)
	0.25 gpm / 0.95 L/min (optional)			0.25 gpm / 0.95 L/min (optional)

\* If the optional solution flow rates are required, contact an Authorized Service Center.

**MACHINE DIMENSIONS**

